

BLOWER & VACUUM BEST PRACTICES[®]

blowervacuumbestpractices.com

October 2022

INDUSTRIAL VACUUM & BLOWER SYSTEMS

18 Vacuum Solution
Ensures Safe &
Sustainable Tires
at Continental

22 Vacuum Upgrades
Improve Operations
at SupremeX

Wastewater Aeration

AERATION BLOWER SYSTEMS

10 Extrapolating PD Blower
Performance

26 Single-Stage Centrifugal
Blower Control Upgrades



Rules for Plant Operators

Rule #1

KEEP IT SIMPLE.

Designed for demanding applications, Kaeser takes the headache out of configuring a superior quality blower package system that's delivered complete with motors, drives, silencers and controls.

Rule #2

STAY IN CONTROL.

Sigma Air Manager (SAM 4.0) has adaptive control, data storage, analysis, and predictive maintenance alerts. SAM will keep your air compressor system performing efficiently *before* there's trouble.

Rule #3

KNOW IT ALL.

An Air Demand Analysis (ADA) helps you see when you are using air, benchmark your system's specific performance, identify leaks, and find periods of low pressure and excessive cycling. Discovery is the first step toward significant energy savings.

To learn more, scan the QR code or visit us at us.kaeser.com/bvbp

Find us at WEFTEC - Booth #1341



us.kaeser.com • 866.516.6888



INDUSTRIAL VACUUM & BLOWER SYSTEMS

18 New Vacuum Solution Ensures Safe & Sustainable Tires at Continental

By Jasmin Markanic, Busch Vacuum Solutions

22 Vacuum Upgrades Improve Operations at SupremeX

By Ron Marshall, Marshall Compressed Air Consulting

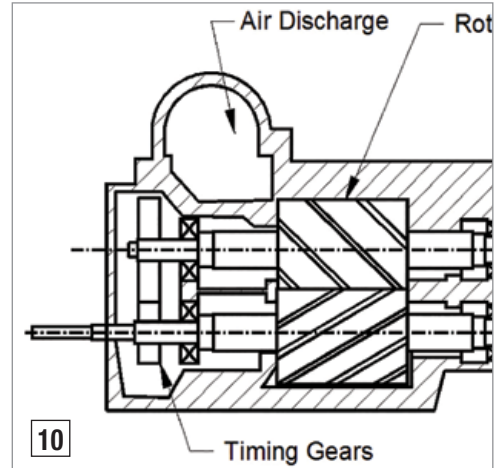

AERATION BLOWER SYSTEMS

10 Extrapolating PD Blower Performance

By Tom Jenkins, JenTech Inc.

26 Get the Most Out of Centrifugal Blower Control Upgrades

By Jeremiah Brown, BSEE/BSCE

EVERY ISSUE

4 From the Editor

5 Industry News

30 Technology News

34 Advertiser Index

34 The Marketplace |
Jobs and Technology



FROM THE EDITOR



Industrial Vacuum & Blower Systems

Vacuum technology is used for handling critical tasks, on textile-cutting machines, at a Continental Tire plant in Germany. Our thanks go to Jasmin Markanic, from Busch Vacuum Solutions, for her case study on a new centralized vacuum system providing energy savings, maintenance savings and production room noise reduction.

SupremeX, a Canadian based envelope and packaging manufacturer, with 11 facilities across six provinces, as well as five facilities in the United States, recently upgraded the vacuum system in their Winnipeg plant. We thank Ron Marshall for his case study documenting the energy savings and reliability improvements.

Aeration Blower Systems

“Extrapolating PD Blower Performance” is the title of our latest article from Tom Jenkins, of JenTech Inc. According to Mr. Jenkins, “Positive Displacement (PD) blowers have been a wastewater treatment workhorse for over 150 years. They are robust and simple to operate. They are often the first choice for small facilities and for applications with wide variations in discharge pressure. When combined with variable frequency drives (VFDs) they provide operational flexibility in flowrate across a wide range of discharge pressures.”

Single-stage centrifugal blowers are a proven technology that have been around for many years. Jeremiah Brown has sent us an article with suggestions to “getting the most out of a controls upgrade for your single-stage centrifugal blower.”

Thank you for investing your time and efforts into *Blower & Vacuum Best Practices*.

RODERICK M. SMITH

Editor

tel: 412-980-9901

rod@airbestpractices.com



Upcoming Webinars

Receive 1.0 PDH Credit by attending our Expert Webinars. Complimentary registration at <https://www.blowervacuumbestpractices.com/magazine/webinars>

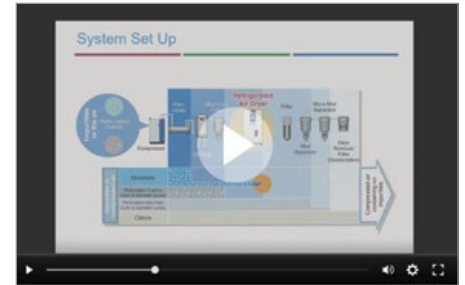

- **November 10, 2022:** ASME PTC 13 Wire-to-Air Performance Test Code for Blower Systems Part 3 – *Presenters John Conover, Consultant, Mark Addison, Senior Engineer, Artesian Water Company and Fred Constantino, S&C Project Engineering Advisor, ASME*
Sponsored by APG-Neuros



Enviro/Tech is a registered trademark.



2022 MEDIA PARTNERS



BLOWER & VACUUM INDUSTRY NEWS

Climeworks Receives Innovation in Vacuum Busch Award 2021

Busch presents the “Innovation in Vacuum Busch Award” once a year. This award honors individuals or companies that use vacuum technology with particularly innovative ideas and thereby serve the well-being of people and the environment. The “Innovation in Vacuum Busch Award” was first presented in 2013 on Busch Vacuum Solutions’ 50th Anniversary.

Limiting the rise in temperature caused by climate change restores a healthy balance of CO₂ content in the atmosphere. This happens by drastically reducing current emissions and by removing unavoidable emissions from the air.

Using Climeworks’ Direct Air Capture technology, CO₂ is filtered directly from the air. CO₂ collectors selectively capture carbon dioxide in a two-step process. First, air is drawn into the collector by a fan. The carbon

dioxide is captured on the surface of a highly selective filter material located inside the collectors. After the filter material is filled with carbon dioxide, the collector is closed, and the temperature is raised to 80 to 100°C – releasing and capturing the pure carbon dioxide. The filtered CO₂ is extracted using MINK claw vacuum pumps from Busch.

It is then mixed with water and injected underground into basalt rock by Climeworks’ partner Carbfix. Over a period of a few years, the CO₂ mineralizes itself and is thus permanently and safely removed from the atmosphere and converted back into rock underground. Climeworks’ technology is powered exclusively by renewable energy or waste heat, and the modular collectors can be combined to create systems of various sizes.

Climeworks and Busch have had a close partnership from the beginning. Climeworks

was awarded the “Innovation in Vacuum Busch Award 2021” for its innovative use of vacuum technology in CO₂ removal. Managing Director and founder of Climeworks Jan Wurzbacher accepted the award with other company representatives during a small ceremony at Busch Vacuum Solutions’ headquarters in Maulburg, Germany.

About Busch Vacuum Solutions

Busch Vacuum Solutions USA sales and manufacturing headquarters is in Virginia Beach, VA where a team of 500 dedicated employees takes care of all their customer’s industrial vacuum needs. Busch USA is part of the global Busch Vacuum Solutions family-owned company with over 3500 employees in more than 40 countries. For more information about Busch, visit www.buschusa.com.

Atlas Copco Acquires TECHNI-V-AC

Atlas Copco has acquired Les pompes à vide TECHNI-V-AC inc. TECHNI-V-AC is a distributor of Atlas Copco vacuum equipment and a service provider, in Canada. TECHNI-V-AC is a privately owned company with 10 employees, located in Montreal, Québec. The acquisition will further strengthen Atlas Copco Vacuum Technique’s presence in Canada.

“We have had a successful partnership with TECHNI-V-AC for many years,” said Geert Follens, Business Area President Vacuum Technique. “This acquisition is an opportunity to develop additional business in the Canadian market.”

The purchase price is not disclosed. The company will operationally become part



Climeworks receives the “Innovation in Vacuum Busch Award 2021” for its innovative use of vacuum technology to remove CO₂.

FREE SUBSCRIPTION

DIGITAL EDITION FREE WORLDWIDE
PRINT EDITION FREE TO U.S. SUBSCRIBERS



**EVERY ISSUE CONTAINS
BEST PRACTICES FOR**

**Industrial Vacuum
Vacuum Generation
Industrial & Aeration
Blowers
Blow-Off Air**

Subscribe Now!



Subscribe at
blowervacuumbestpractices.com

Blower & Vacuum Industry News

of the Vacuum Technique Service Division within the Vacuum Technique Business Area.

Atlas Copco Group

Great ideas accelerate innovation. At Atlas Copco we have been turning industrial ideas into business-critical benefits since 1873. By listening to our customers and knowing their needs, we deliver value and innovate with the future in mind. In 2021, Atlas Copco had revenues of BSEK111 and at year end about 43 000 employees. For more information, visit www.atlascopcogroup.com.

Brown and Caldwell Announce New COO

Brown and Caldwell announced Euan Finlay has been promoted from senior vice president to chief operating officer (COO). A senior executive with 25 years of experience, Finlay excels in leading organizations and teams to deliver excellence to clients while driving sustainable growth.

Throughout his career, he has held executive roles in operations, design, and construction businesses in numerous international locations focused on developing client solutions for environmental, water, and wastewater infrastructure. He has led multi-million-dollar businesses, managed company-wide project delivery, and directed mergers and acquisitions as a Fortune 500 company executive.

Before joining the firm in 2019 as director of business transformation, Finlay was an operations executive for a leading provider of design, design/build, and program management services.

Brown and Caldwell CEO Rich D'Amato said, "Euan has a strong track record of challenging organizations to achieve their potential. As Brown and Caldwell continues to evolve and grow, Euan's operations expertise will be a key driver in building our future success to better serve clients, recruit and retain top talent, and positively impact our communities."

As COO, Denver-based Finlay will interface with the firm's leadership to ensure strategic and technical objectives translate to operational capabilities aligned with business targets.

Furthermore, he will play a key role in ensuring cultural imperatives are communicated and supported operationally throughout the 1,800 employee-owned company.

About Brown and Caldwell

Headquartered in Walnut Creek, California, Brown and Caldwell is a full-service environmental engineering and construction firm with 52 offices



Euan Finlay, COO, Brown and Caldwell.

and 1,800 professionals across North America and the Pacific. For 75 years, our creative solutions have helped municipalities, private industry, and government agencies successfully overcome their most challenging water and environmental obstacles. As an employee-owned company, Brown and Caldwell is passionate about exceeding our clients' expectations and making a difference for our employees, our communities, and our environment. For more information, visit www.browncaldwell.com.

Black & Veatch Selects Mario Azar as New Chairman & CEO

The Black & Veatch Board of Directors announced it has selected Mario Azar as the chairman and CEO for the company upon the decision of Steve Edwards to retire after 44 years of outstanding leadership, service and dedication. Azar, currently serving as president, Energy & Process Industries, becomes only the eighth senior leader in the founder, managing partner or chair role in Black & Veatch's 107-year history.

"As global megatrends reshape the critical infrastructure markets we serve, the Black & Veatch Board of Directors is thrilled to select Mario based on his vast global experience, proven leadership capabilities, innovative and collaborative approach and strong focus on client relationships," said Edwards. "Since joining the company in 2018, Mario has been the architect of an effort that is repowering the power industry; as well as in the strategic repositioning of our company to address the megatrends our clients and the world faces. This success, and Mario's leadership

throughout our company-wide transformation, highlight the unique skills and experience that make him the ideal choice to lead the company into the future."

Azar's global leadership experience spans more than 32 years in the energy and industrial fields, much of it in engineering and construction solutions. Prior to joining Black & Veatch in 2018 as the president of the global power business, Azar served in multiple executive roles and led large global businesses at Siemens, and previously Westinghouse, including as CEO of Siemens Oil & Gas and Marine, an engineered solutions and integration business unit operating globally



The Black & Veatch Board of Directors announced it has selected Mario Azar as the chairman and CEO for the company.

GIVE YOUR PRODUCTIVITY A BOOST

- Improve Evacuation
- Increase Uptime
- Predict Maintenance



ASK ABOUT 0% FINANCING

For select products. Terms and conditions apply.

Busch offers the latest vacuum technology with solutions that perfectly meet your packaging and service needs, for applications including forming, foil handling, blister packaging, stacking and palletizing, carton erecting, MAP packaging, labeling and more.

Rely on the trusted name for vacuum. Rely on Busch.

1-800-USA-PUMP | info@buschusa.com | buschusa.com

**U
BUSCH**

VACUUM SOLUTIONS

Blower & Vacuum Industry News

in over 21 countries. He also founded a private consulting firm focused on energy and heavy industry.

“It is a true honor to be selected to lead Black & Veatch, a company with such deep history and a stellar reputation built by a world-class team of global professionals,” Azar said. “The portfolio of solutions Black & Veatch offers, coupled with our transformed business model aligning with the megatrends reshaping our world, positions us to continue fulfilling our mission of Building a World of Difference for generations to come. I am excited about the future of our company and growing partnerships with our clients as their business needs evolve.”

The company will name a successor to fill Azar’s current role in the near future.

About Black & Veatch

Black & Veatch is a 100-percent employee-owned global engineering, procurement, consulting, and construction company with a more than 100-year track record of innovation in sustainable infrastructure. Since 1915, we have helped our clients improve the lives of people around the world by addressing the resilience and reliability of our most important infrastructure assets. Our revenues in 2021 exceeded US\$3.3 billion. For more information, visit www.bv.com.

Sulzer Begins Baton Rouge Service Center Expansion Project

Sulzer has begun the construction of an all-new 7,200 sq. ft. expansion to its Baton Rouge Service Center in Louisiana. Breaking ground in



This expansion has been made possible by our products, services, customer relationships and expertise.

a ceremony on December 9, 2021, the project is designed to enhance repair, reengineering and upgrade services for operators of all types of rotating equipment in the US Gulf Coast area.

Glenn Doerksen, President Pump Services NAM at Sulzer, said during the ceremony, “It’s really an exciting day for Sulzer and the Baton Rouge service center. This expansion has been made possible by our products, services, customer relationships and expertise. I’d like to thank everyone who has enabled this success – from here we grow and add to our history.”

As a premier independent service provider for rotating equipment and a global pump original equipment manufacturer (OEM), Sulzer offers its customers unrivalled around-the-clock services designed to maximize equipment reliability and availability. Expanding its facilities at Baton Rouge

is a key component of Sulzer’s ongoing investment strategy, growing its market-leading capabilities through enhanced service center capacity and equipment.

Once complete, Sulzer customers will benefit from even shorter lead times on all repair, reengineering and upgrade projects – especially for large vertical pumps and small steam turbines. Throughout the duration of the expansion, Sulzer’s usual high levels of service will continue to be available to customers.

The Baton Rouge Service Center is a leading service provider to the power generation, petrochemical, steel and heavy-manufacturing sectors as well as many others. A part of Sulzer’s global network of service centers, Baton Rouge offers a specialized range of 24/7 in-house and field engineering services, delivering projects on reduced lead times and to exacting standards.

The expansion will add to the 10,500 sq. ft. of floor space currently available at the service center. New machines, upgraded cranes with a 20-ton lifting capacity as well as a dedicated painting and blast booth will also be installed as part of the project.

Beyond supporting Sulzer customers, the new service center expansion will provide increased job opportunities in the local area. Sulzer is looking to hire new mechanics, machinists, office staff, sales teams and apprentices, once construction work is complete.

About Sulzer

Sulzer is a global leader in fluid engineering. We specialize in pumping, agitation, mixing, separation and application technologies for fluids of all types. Our customers benefit from our commitment to innovation, performance and quality and from our responsive network of 180 world-class production facilities and service centers across the globe. Sulzer has been headquartered in Winterthur, Switzerland, since 1834. In 2020, our 15,000 employees delivered revenues of CHF 3.3 billion. The Pumps Equipment division specializes in pumping solutions specifically engineered for the processes of our customers. We provide pumps, agitators,

compressors, grinders and screens developed through intensive research and development in fluid dynamics and advanced materials. We are a market leader in pumping solutions for water, oil and gas, power, chemicals and most industrial segments. Throughout the Americas, Sulzer provides cutting-edge parts as well as maintenance and repair solutions for pumps, turbines, compressors, motors and generators. We service our own original equipment as well as third-party rotating equipment operated by our customers. Our technology-based solutions maximize reliability and lifecycle cost effectiveness. For more information on Sulzer, visit www.sulzer.com.

Need More Vacuum Tips and Tutorials?

Learn Industrial Vacuum Best Practices - View Our **FREE* On-Demand Webinars**

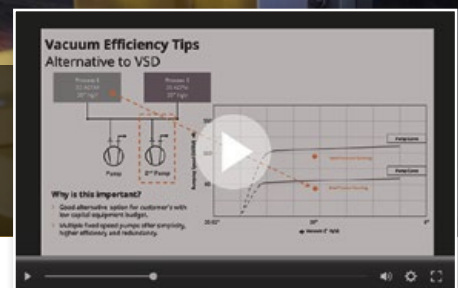

Our Extensive Library of Webinars Includes These Titles

- Vacuum Specification Fundamentals: Flow vs. Pressure
- How to Correctly Size Vacuum Pumps
- 5 Tips on Optimizing VSD Vacuum Pumps
- Pros & Cons of Centralized Vacuum Systems

*Included with your free magazine subscription

Get FREE Instant Access* at blowervacuumbestpractices.com/magazine/webinars



Extrapolating PD Blower Performance

By Tom Jenkins, JenTech Inc.

► Positive Displacement (PD) blowers have been a workhorse for wastewater treatment for over 150 years. They are robust and simple to operate. They are often the first choice for small facilities and for applications with wide variations in discharge pressure. When combined with variable frequency drives (VFDs) they provide operational flexibility in flowrate across a wide range of discharge pressures.

The performance of PD blowers may be provided as tabulated data or in a performance curve. Regardless of format, the data is provided based on specific inlet and discharge conditions. Whether designing a new system or evaluating an existing one, the design engineer frequently needs to evaluate performance at conditions that differ from those provided in the available data.

There are simple calculation methods available for extrapolating the performance of a PD blower from one set of operating conditions to another. These methods provide sufficient accuracy for most design and evaluation purposes. The accuracy achieved will be better than the $\pm 4\%$ applied to most published data.

However, for establishing and evaluating power guarantees or other purposes requiring high levels of accuracy the manufacturer should be consulted. If precise values are needed the rigorous evaluations provided in codes such as ASME PTC 13 should be used.

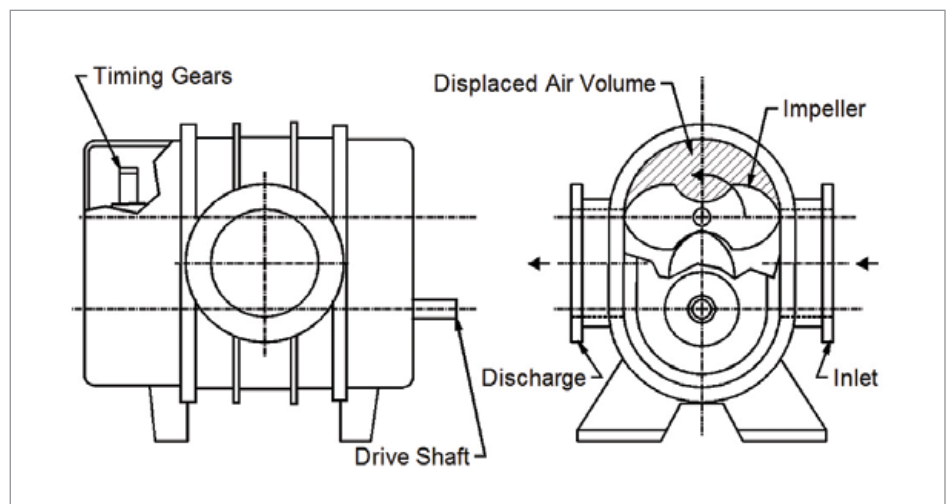

Figure 1: Example of a Lobe Type PD Blower

Basic Performance of PD Blowers

Wastewater applications for PD blowers are dominated by two basic types. Both are available as bare blowers, but current applications favor complete packages with accessories like filters, silencers, VFDs, and controls preassembled in a sound attenuating enclosure.

The lobe type blower, sometimes referred to as a “Roots type blower”, has two counter-rotating shafts with identical two or three lobed impellers on each. Air flow is around the periphery of the impeller and perpendicular to the shafts. Peak efficiency occurs at the maximum rpm. [See Figure 1.]

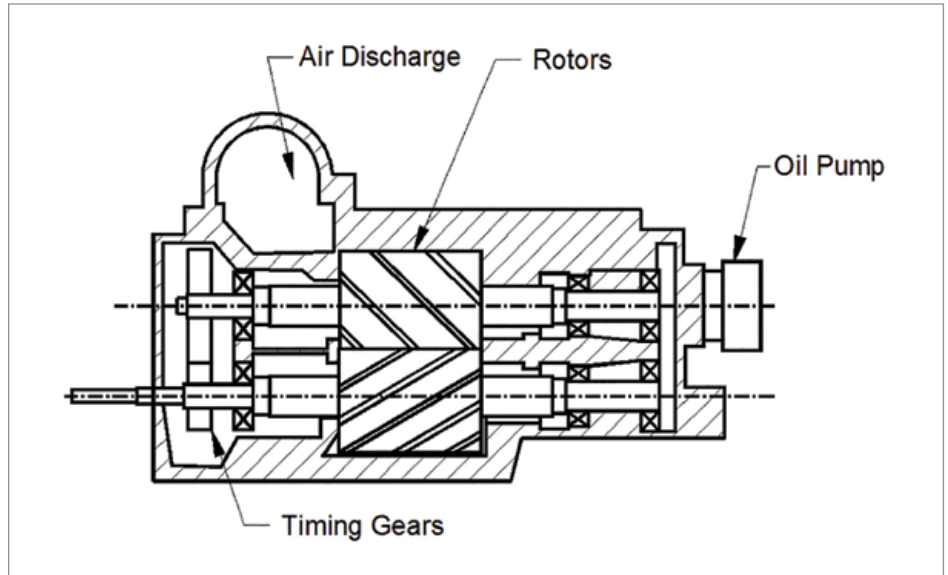
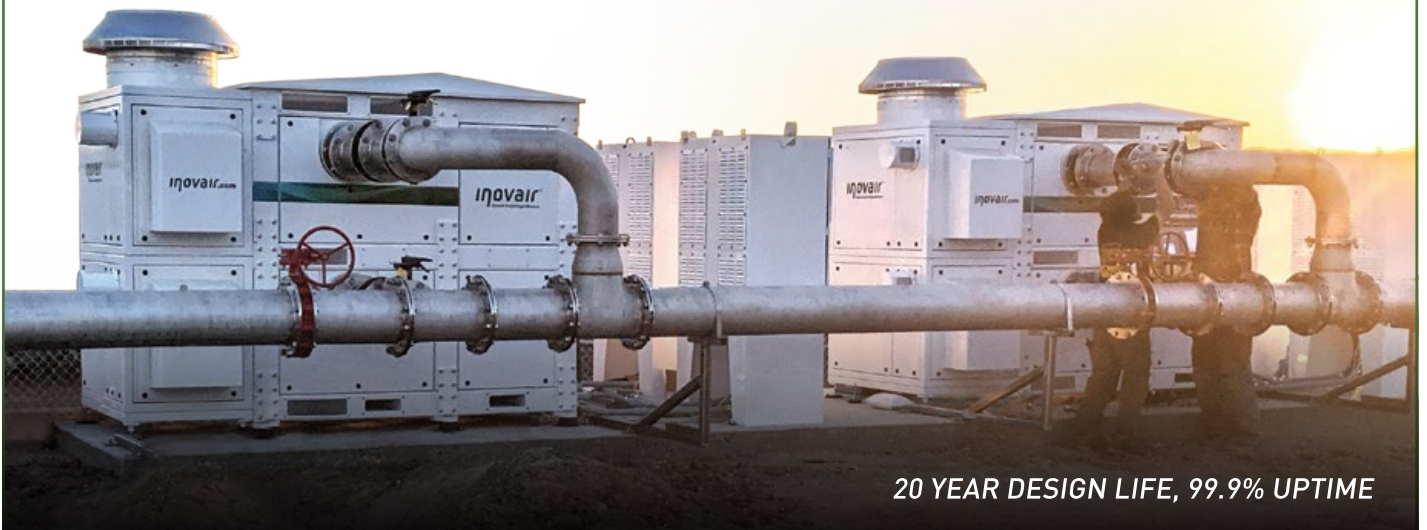

Figure 2: Example of a Screw Type PD Blower

**LOWEST COST OF OWNERSHIP
HIGHEST EFFICIENCY**

MANUFACTURED AND SERVICED IN THE USA
500 HP DOWN TO 15 HP



20 YEAR DESIGN LIFE, 99.9% UPTIME

inovair[®]
Geared Centrifugal Blowers

INOVAIR.com
 η = Efficiency™



Extrapolating PD Blower Performance

The screw type blower also has two rotors, each consisting of a counter-rotating shaft with an impeller. One impeller is male and the

other female, and each has a different number of lobes. The configuration of the impellers establishes a fixed volume ratio as the air

flows axially from inlet to discharge. The peak efficiency usually occurs at reduced speed and when the pressure ratio matches the volume ratio of the impellers. [See Figure 2.]

Both types of PD blowers have similar performance characteristics:

- Airflow rate proportional to speed: A fixed volume of air is moved from inlet to discharge with every rotation. Changing the volumetric flow rate requires changing speed.
- Variable discharge pressure: The pressure at the blower discharge will inherently rise to the level required to push the displaced volume into the system.
- Proportional power: Power at the blower shaft is a function of the pressure difference across the blower and the air flowrate.
- Linear performance: For a fixed pressure differential the relationship of power to air flow can be expressed in a linear equation using the form $y = mx + b$. Note that the intercept is typically non-zero. [See Figure 3.]

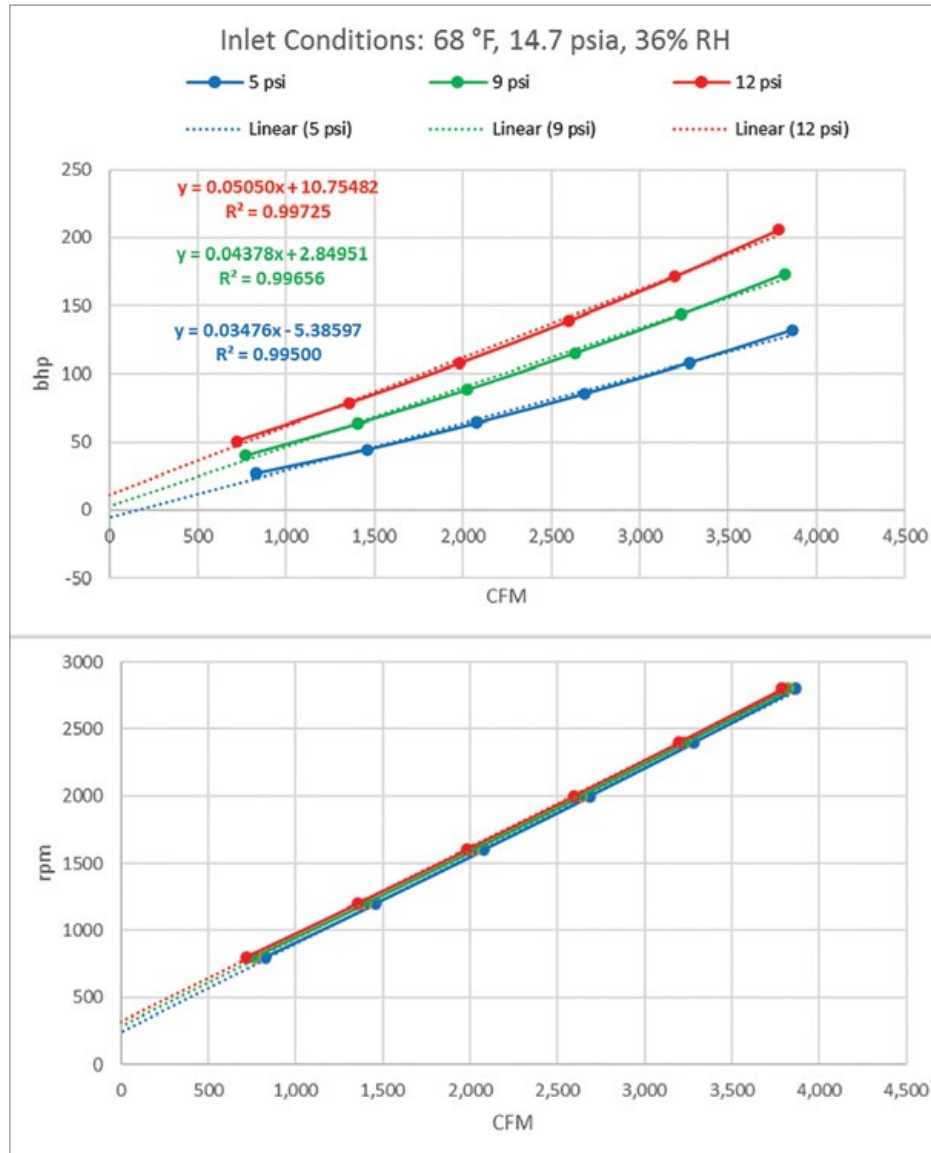

Figure 3: Example Screw Blower Performance

rpm	6 psi		10 psi		12 psi	
	cfm	bhp	cfm	bhp	cfm	bhp
1160	3156	104	3028	166	2974	198
1460	4086	137	3958	216	3904	256

Performance at inlet conditions of 68 °F, 14.7 psia, 36% RH

Figure 4: Example of Tabulated Performance Data

The performance characteristics may be provided as a family of curves. [See Figure 3.] It is also common for performance data to be tabulated. [See Figure 4.]

A linear equation can be readily obtained from as few as two data points by using a spreadsheet chart function and adding a trendline. Expanding trend parameters to four significant figures is suggested.

Alternatively the slope and intercept can be obtained from the data using standard algebraic methods.

$$m = \frac{y_2 - y_1}{x_2 - x_1}$$

$$b = y_1 - m \cdot x_1$$

The provided data is only correct for the specific inlet and discharge conditions indicated. It is rare that these conditions meet the application's needs. Linear extrapolation methods are applicable to both types of PD blower.

Pressure

System discharge pressure is important for two reasons. It establishes the motor torque and power needed. It also affects the required rotational speed, since the internal leakage of air from discharge back to inlet, known as slip, increases slightly as differential pressure across the blower increases.

Tabulated data and performance plots usually include data for several different discharge pressures. Linear interpolation should use two pressures that bracket the required pressure. Two sets of interpolation are necessary:

- Interpolate flow as a function of pressure at two different speeds
- Interpolate power as a function of pressure at two different speeds

The general formula for linear interpolation is:

$$y_{new} = y_1 + (x_{new} - x_1) \cdot \frac{(y_2 - y_1)}{(x_2 - x_1)}$$

weftec 2022
the water quality event™

October 10-12
Booth No. 843

WHAT DO YOU EXPECT FROM A TURBO BLOWER?

AERZEN TURBO

- ✔ Operation in hot environments (up to 122 Degrees F)
- ✔ Long-life airfoil bearing (>80,000 start cycles)
- ✔ Superior response to changes in system demand (sequencing, upsets)
- ✔ Operation with other blower technologies



LET'S TALK

Tom McCurdy, Director of Environmental Sales
Phone: +1 610 656 1683
E-Mail: tom.mccurdy@aerzen.com
Web: www.aerzen.com



AERZEN

Compressed air, gas
and vacuum solutions

Extrapolating PD Blower Performance

The power and flow rate are based on the pressure differential across the blower. The new differential pressure used in extrapolations must include allowances for inlet losses from filters, silencers, and piping.

The power given is typically the brake horsepower (bhp) at the blower drive shaft. Calculations for electrical power consumption must include considerations of belt drive efficiency as well as motor and VFD efficiencies.

Flow Rate

There are two aspects of airflow rate that require compensation. First is establishing the volumetric flow rate that corresponds to the process demand. Second is establishing the blower speed that will provide the necessary airflow.

In some processes, such as channel aeration, the process demand is based on volumetric flow rate. For most wastewater processes the demand for air is based on delivering a required amount of oxygen. In this case the process demand is usually given as standard cubic feet per minute (SCFM). In the wastewater industry standard conditions are 68 °F, 14.7 psia, and 36% RH. To apply the process demand to the PD blower's performance it is necessary to convert SCFM to the equivalent volumetric flow rate at the actual blower inlet conditions, inlet cfm (ICFM).

Ignoring relative humidity, the conversion from SCFM to inlet volumetric flowrate is straight forward:

$$ICFM = SCFM \cdot \frac{^{\circ}R}{35.92 \cdot \text{psia}}$$



Library of Aeration Blower Webinars Includes

- Techniques for Determining Savings from Aeration Blowers
- Sorting Through the Menu of Aeration Blower Technologies
- Aeration Blower Turndown Strategies
- Where Does Blower Air Go? Process Fundamentals

Library of Aeration Blower Articles Includes

- Madison Utilities Wastewater Treatment Plant Blower Upgrade Saves Energy
- Sewage Treatment Plant Retrofits Diffusers to Cut Energy Consumption 50%
- Black & Veatch: Ensuring Aeration Blowers Meet the Needs of Wastewater Treatment Plants
- Calculating Most-Open-Valve Aeration Control

*Included with your free magazine subscription

Power

The power demand of a PD blower is comprised of several components. In addition to the power required for compression there are the losses resulting from mechanical friction of gears and bearings. Internal leakage increases power demand because some of the air compressed at the discharge flows back to the inlet side of the impellers. Screw blowers may have additional losses if the actual pressure ratio across the blower is lower than the internal pressure ratio conforming to the change in volume through the impellers. By extrapolating power demand from reported data the losses are accounted for without the need to identify specific sources of inefficiency.

The motor torque required for PD blowers of either type is proportional to pressure differential. For a given inlet and discharge pressure the motor amperage is nearly constant. Since heating of the motor is proportional to I² the motor temperature increase may limit blower turndown and will affect VFD sizing.

Blower internal temperature increase rises with higher differential pressure and lower efficiency. At reduced speed excess blower temperature may occur, which often limits turndown. For lobe type PD blowers the turndown is limited to approximately 50%. For screw type PD blowers the turndown may be 60% or more. During final design the turndown limits should be verified with suppliers.

Example

An example based on the tabulated data in Figure 4 will illustrate the procedure.

Assume the process demand is 3,000 SCFM and the required discharge pressure is 8.3 psig. Barometric pressure is 13.7 psia and inlet losses are 0.2 psi. The ambient temperature at worst case design conditions is 105 °F.

The first step is to determine the required differential pressure and actual pressure at the blower inlet:

$$\Delta p = p_{\text{disch}} + \Delta p_{\text{inlet}} = 8.3 + 0.2 = 8.5 \text{ psi}$$

$$p_{\text{inlet}} = p_{\text{barometric}} - \Delta p_{\text{inlet}} = 13.7 - 0.2 = 13.5 \text{ psia}$$

The next step is to extrapolate the tabulated performance data for airflow rate and power to the required pressure at each speed. For the first speed, 1160 rpm, the result is:

$$q_{\text{new}} = q_1 + (\Delta p - p_1) \cdot \frac{q_2 - q_1}{p_2 - p_1} = 3156 + (8.5 - 6.0) \cdot \frac{3028 - 3156}{10.0 - 6.0} = 3076$$

$$P_{\text{new}} = P_1 + (\Delta p - p_1) \cdot \frac{P_2 - P_1}{p_2 - p_1} = 104 + (8.5 - 6.0) \cdot \frac{166 - 104}{10.0 - 6.0} = 142.8$$

The calculation is repeated using values from the second speed, 1460 rpm and the results tabulated:

Performance at 8.5 psi Δp, 68 °F, 14.7 psia

Blower shaft rpm	ICFM	bhp
1160	3076	142.8
1460	4006	186.4

This data can also be used to create performance curves at the required inlet conditions. [See Figure 5.]

The next step is to develop the linear equations for speed and power vs. inlet airflow rate:

$$m_{\text{rpm}} = \frac{\text{rpm}_2 - \text{rpm}_1}{q_2 - q_1} = \frac{1460 - 1160}{4006 - 3076} = 0.3226$$

$$b_{\text{rpm}} = \text{rpm}_1 - m_{\text{rpm}} \cdot q_1 = 1160 - 0.3226 \cdot 3076 = 167.7$$

$$m_{\text{bhp}} = \frac{P_2 - P_1}{q_2 - q_1} = \frac{186.4 - 142.8}{4006 - 3076} = 0.04688$$

$$b_{\text{bhp}} = P_1 - m_{\text{bhp}} \cdot q_1 = 142.8 - 0.04688 \cdot 3076 = -1.403$$

Extrapolating PD Blower Performance

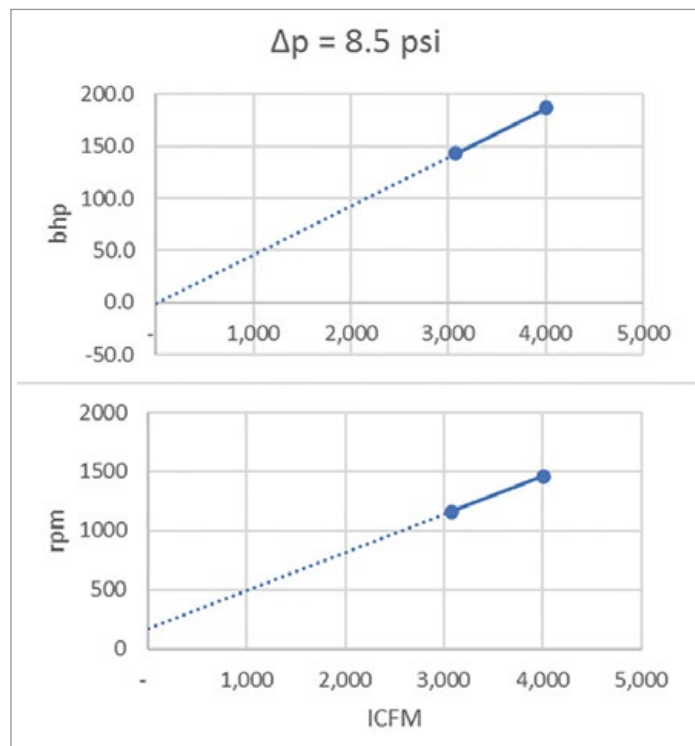

Figure 5: Performance Curve for Example Problem

The process demand, SCFM, must be converted to the equivalent ICFM based on the ratios of absolute temperature and absolute pressure to standard conditions:

$$\text{ICFM} = \text{SCFM} \cdot \frac{(460 + T_{\text{inlet}})}{35.92 \cdot p_{\text{inlet}}} =$$

$$3000 \cdot \frac{460 + 105}{35.92 \cdot 13.5} = 3495 \text{ CFM}$$

The blower speed and the power demand at the blower shaft can be calculated:

$$\text{rpm} = m_{\text{rpm}} \cdot \text{ICFM} + b_{\text{rpm}} =$$

$$0.3226 \cdot 3495 + 167.7 = 1295 \text{ rpm}$$

$$\text{bhp} = m_{\text{bhp}} \cdot \text{ICFM} + b_{\text{bhp}} =$$

$$0.04688 \cdot 3495 - 1.403 = 162.4 \text{ hp}$$

This is the speed and power needed to provide the required air flow at the actual inlet and discharge conditions. If the

performance is needed at alternate flows with the same inlet conditions and discharge pressure the equation for performance is unchanged. The alternate SCFM can be converted to ICFM, and the speed and power calculated for the alternate flow rate.

If the change in pressure differential at two evaluation points is small, approximately 1 psi or less, it is not necessary to develop new equations. Pressure differential does not have a major effect on the relationship between flow and speed. The change in power demand is proportional to the ratio of pressure differential at the two points:

$$\text{rpm}_1 \approx \text{rpm}_2$$

$$\text{bhp}_2 \approx \text{bhp}_1 \cdot \frac{\Delta p_2}{\Delta p_1}$$

Summary

The PD blower is the most appropriate technology for many wastewater applications. Published or submittal performance data typically does not reflect actual operating conditions. Energy evaluations and preliminary design often require evaluating performance quickly at a variety of conditions. Simple linear equations may be developed to extrapolate provided data to new conditions. This allows evaluation of the blower's performance at actual application conditions with accuracy that exceeds most needs. **BP**

About the Author

Tom Jenkins has over forty years' experience in blowers and blower applications. As an inventor and entrepreneur, he has pioneered many innovations in aeration and blower control. He is an Adjunct Professor at the University of Wisconsin, Madison. Tom is the current Chair of the ASME PTC 13 Committee. For more information, visit www.jentechinc.com.

To read similar articles on **Aeration Blower Technology**, please visit <https://blowervacuumbestpractices.com/technology/aeration-blowers>.



Visit our Webinar Archives to listen to expert presentations on **Aeration Blower Systems** at <https://www.blowervacuumbestpractices.com/magazine/webinars>

PROUDLY PRESENTING THE 2022 EXPERT WEBINAR SERIES



Tim Dugan, P.E.
President and Principal Engineer, Compression Engineering Corp.



Antonio Mayne, P.E.
Utilities Optimization Engineer, Molson Coors Beverage Company



Ron Marshall
Chief Auditor, Marshall Compressed Air Consulting



Julie Gass
Lead Mechanical Process Engineer, Black & Veatch



Loran Circle
Senior Consultant, Circle Training & Consulting



Tom Taranto
Owner, Data Power Services



Francisco Lara
Manager, Airtec Global LLC

JAN 20 **Air Compressor Component Function, Troubleshooting & Maintenance**

Presenter Loran Circle, Senior Consultant, Circle Training & Consulting – Sponsored by BEKO Technologies
Thursday, January 20, 2022 – 2:00PM EST

FEB 17 **Compressed Air Piping System Sizing & Design**

Presenter Tim Dugan, P.E., President and Principal Engineer, Compression Engineering Corporation – Sponsored by Trace Analytics and Unipipe
Thursday, February 17, 2022 – 2:00PM EST

MAR 10 **On-site Nitrogen Generation Replacing Bulk Liquid Nitrogen**

Presenter Antonio Mayne P.E., Utilities Optimization Engineer, Molson Coors Beverage Company – Toronto Brewery – Sponsored by Atlas Copco
Thursday, March 10, 2022 – 2:00PM EST

MAR 24 **How to Hunt for Vacuum Leaks: Is it Worthwhile?**

Presenter Ron Marshall, Chief Auditor, Marshall Compressed Air Consulting – Sponsored by Best Practices 2022 EXPO & Conference
Thursday, March 24, 2022 – 2:00PM EST

APR 28 **Air Compressor Cooling, Water- or Air-Cooled?**

Presenter Tom Taranto, Owner, Data Power Services – Sponsored by Kaeser Compressors
Thursday, April 28, 2022 – 2:00PM EST



Hiran de Mel
Senior Project Manager and Principal Technologist, Jacobs



Mark Addison
Senior Engineer, Artesian Water Company

MAY 12 **IIOT Solutions for Multiple and Multi-brand Compressors Remote Monitoring**

Presenter Tim Dugan, P.E., President and Principal Engineer, Compression Engineering Corporation – Sponsored by Kaishan
Thursday, May 12, 2022 – 2:00PM EST

MAY 19 **ASME PTC 13 Wire-to-Air Performance Test Code for Blower Systems Part 1**

Presenters Julie Gass, Lead Mechanical Process Engineer, Black & Veatch, Fred Constantino, S&C Project Engineering Advisor, ASME and Andrew Balberg, President, Lone Star Blower and Compressor – Sponsored by Lone Star Blower & Compressor
Thursday, May 19, 2022 – 2:00PM EST

JUN 09 **Sizing and Maintaining Compressed Air Systems**

Presenter Loran Circle, Senior Consultant, Circle Training & Consulting – Sponsored by Kaishan
Thursday, June 9, 2022 – 2:00PM EST

JUN 23 **Compressed Air System Design for Lowest kW/100scfm**

Presenter Tom Taranto, Owner, Data Power Services – Sponsored by VPInstruments and BEKO Technologies
Thursday, June 23, 2022 – 2:00PM EST

JUL 21 **Applications for Adiabatic Cooling Technology**

Presenter Bert J. Wesley, Sr. Principal Industrial Plant Engineering Practice Leader, Woodard & Curran – Sponsored by Evapco
Thursday, July 21, 2022 – 2:00PM EST

JUL 28 **ASME PTC 13 Wire-to-Air Performance Test Code for Blower Systems Part 2**

Presenters Hiran de Mel, Senior Project Manager and Principal Technologist, Jacobs and Lloyd Slezak, Consulting Engineer (ret), Brown and Caldwell – Sponsored by Howden
Thursday, July 28, 2022 – 2:00PM EST

AUG 18 **VFD Vacuum Pumps Do's and Don'ts**

Presenter Ron Marshall, Chief Auditor, Marshall Compressed Air Consulting – Sponsored by Busch Vacuum Solutions
Thursday, August 18, 2022 – 2:00PM EST

AUG 25 **Avoiding Production Downtime: Realtime Compressed Air Quality Monitoring and Audits**

Presenter Francisco Lara, Manager, Airtec Global LLC – Sponsored by SUTO-ITEC
Thursday, August 25, 2022 – 2:00PM EST

OCT 20 **How to Determine the Ideal Physical Location of a Cooling Tower**

Presenter Nick McCall, P.E., Technical Manager, Woodard & Curran – Sponsored by SPX Cooling Technologies, Inc.
Thursday, October 20, 2022 – 2:00PM EST

OCT 27 **Compressed Air: What You Don't Know Can Hurt You**

Presenter Ron Marshall, Chief Auditor, Marshall Compressed Air Consulting – Sponsored by VPInstruments and Kaeser Compressors
Thursday, October 27, 2022 – 2:00PM EST

NOV 10 **ASME PTC 13 Wire-to-Air Performance Test Code for Blower Systems Part 3**

Presenters John Conover, Consultant, Mark Addison, Senior Engineer, Artesian Water Company, and Fred Constantino, S&C Project Engineering Advisor, ASME – Sponsored by APG-Neuros
Thursday, November 10, 2022 – 2:00PM EST

DEC 08 **Compressed Air: Reliable Source for Nitrogen Generation**

Presenter Loran Circle, Senior Consultant, Circle Training & Consulting – Sponsored by Rogers Machinery and Parker
Thursday, December 8, 2022 – 2:00PM EST

Register for Free Today at airbestpractices.com/webinars

Missed a Webinar? Register to View from our Archives at <https://www.airbestpractices.com/webinars>

SPONSORED BY

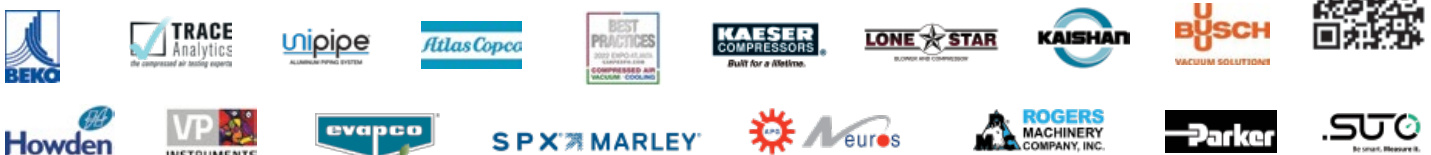



New Vacuum Solution Ensures Safe & Sustainable Tires at Continental

By Jasmin Markanic, Busch Vacuum Solutions

Continental tires are manufactured using state-of-the-art vacuum technology from Busch. Photo: Continental Reifen GmbH

▶ Continental Reifen Deutschland GmbH produces high-quality tires for cars and vans at its production plant in Aachen, Germany. In its tire manufacturing process, Continental uses an extremely effective and, above all, efficient method of vacuum generation, in which a central vacuum supply from Busch Vacuum Solutions supplies the necessary vacuum to ensure secure handling on three textile-cutting machines. In addition to significantly reducing noise in the production room, this vacuum solution also leads to a high level of savings when it comes to the tire manufacturer's energy and maintenance costs.

Nearly every third vehicle in Europe drives on tires made by Continental, which mixes the natural rubber raw material itself, then

extrudes it and, after several intermediate steps, processes it into ready-to-mount tires. A single tire consists essentially of three main components: textile cord, steel wire and a natural rubber mixture. These three basic materials are combined in a specific way in the individual components of the tire, then assembled as carcass and belt, formed into a tire and hardened.

The textile cord consists of a large number of textile threads and is inserted into a calender using a large uncoil device. This is where the textile cord is coated with natural rubber, and a rubberized web is created in the form of a continuous long strip that is less than one millimeter thick. This web is cut to the desired width perpendicular to the thread

pattern and rolled into a textile roll again for further processing. The textile material is later directly attached to the innermost layer of rubber. It functions as a reinforcing element on the inside of the tire. The radial orientation of the threads ensures additional stability. This layer primarily influences the carrying capacity of the tire as well as the suspension behavior and handling characteristics.

Previous Vacuum Supply Consumed Enormous Amount of Energy

Vacuum technology is used for handling tasks at the textile-cutting machine. The rubberized web is cut to the desired length and then directly applied to another strip using pick-and-place. Here, precise positioning is the most critical aspect when it comes to the quality of

the finished textile web. The individual layers need to lay exactly on top of one another. One side channel blower used to be installed in each of three textile-cutting machines.

These provided the necessary vacuum for handling the strips of textile. The blowers ran constantly at full power and thus consumed enormous amounts of energy. In addition, they created significant noise pollution for the production staff.

Dry, Efficient, and Quiet – The Sustainable Vacuum Solution

An employee from Continental Reifen suggested via the internal Idea Management that someone



Vacuum supply with two MINK MV claw vacuum pumps for handling textile cords. Photo: Busch Vacuum Solutions

should take a closer look at the vacuum supply of the textile-cutting machines. Their primary concern was the acute noise pollution due to the previously used side channel blowers. Because Continental is always searching for potential ways to improve, they decided to look for a more ergonomic and efficient solution.

The vacuum experts at Busch Vacuum Solutions recommended using a MINK claw vacuum pump to generate vacuum and initially provided a test system. It only took a couple of days for Ingmar Heinze, Head of Utilities and Sustainable Infrastructure, to become convinced that he had found the right solution for generating vacuum. After the test run, a vacuum system with two MINK MV Synchro vacuum pumps was installed at Continental. This system replaced the previous three side channel blowers and now centrally supplies the necessary vacuum for several textile-cutting machines via stainless steel pipes. MINK MV Synchro vacuum pumps are fitted with a frequency converter and demand-driven control unit as standard. The vacuum pumps detect the pumping speed they need to provide in an ongoing process to securely hold the rubberized textile cord and precisely place it.

New Vacuum Supply Provides Clear Benefits

Fortunately, using this new vacuum system did more than just solve the main problem of noise pollution. The previous side channel blowers reached noise levels of 94 dB. This meant high levels of noise pollution for the staff in the production hall. With the new vacuum system from Busch, the noise level of the vacuum unit

FREE SUBSCRIPTION

DIGITAL EDITION FREE WORLDWIDE
PRINT EDITION FREE TO U.S. SUBSCRIBERS

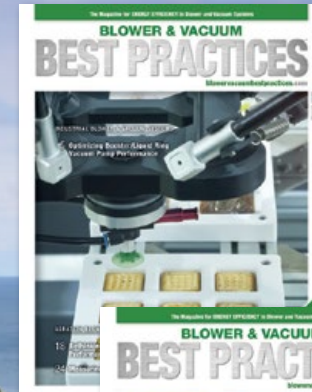

EVERY ISSUE CONTAINS
BEST PRACTICES FOR

Industrial Vacuum
Vacuum Generation

Industrial & Aeration
Blowers

Blow-Off Air

Subscribe Now!



Subscribe at
blowervacuumbestpractices.com

New Vacuum Solution Ensures Safe & Sustainable Tires at Continental



Piping system for the vacuum supply of the textile-cutting machines at Continental Reifen Deutschland GmbH. Photo: Busch Vacuum Solutions

cannot even be detected because it is drowned out by normal ambient noise – meaning it is below 72 dB.

In addition to the significant noise reduction, the new vacuum system also led to significant energy savings. Thanks to the demand-driven control, full performance is not always used, meaning that the vacuum system often operates with lower rotational speed and power consumption. The system also automatically shuts off when no textile strips need to be held. The power consumption of the previously used blowers was generally 15 kWh. When measurements were taken with the new vacuum system, an average energy consumption of only 800 watts per hour was determined.

That equals energy cost savings of over 90 percent. So the investment promptly paid for itself and, due to the energy aspect, it is eligible for funding from the German Federal Office of Economics and Export Control (BAFA).

The new solution also saves close to 90 percent of the annual maintenance costs. The side channel blowers required intensive repairs and were therefore a source of high costs. MINK MV claw vacuum pumps provide completely dry compression of intake air and thus work without operating fluids such as oil or water. This makes the vacuum pumps virtually maintenance-free. Downtimes for servicing also used to present a problem. For the new vacuum system with two MINK claw vacuum pumps, the few necessary servicing operations can be performed on one of the two vacuum pumps while the other one continues to supply the system with vacuum. This means no more interruptions and higher availability of the textile cutting machines.

The new vacuum system has now been running since January – to Ingmar Heinze’s complete satisfaction. “We are very satisfied with our new vacuum supply for handling textile strips during tire manufacturing. We were not only able to significantly reduce noise pollution for our employees, but were also able to significantly reduce energy consumption and maintenance effort, and increase the productivity of the system. That is a prime example of sustainable improvement!” **BP**

***About Busch Vacuum Pumps and Systems**
Busch Vacuum Pumps and Systems is one of the largest manufacturers of vacuum pumps, blowers and compressors in the world. Our products are at the forefront of vacuum and low-pressure technology. For more information, visit www.buschvacuum.com.*

For similar articles on **Industrial Vacuum Systems**, visit <https://www.blowervacuumbestpractices.com/technology/rough-vac>



Visit our Webinar Archives to listen to expert presentations on **Industrial Vacuum Technology** at <https://www.blowervacuumbestpractices.com/magazine/webinars>

BLOWER & VACUUM BEST PRACTICES

blowervacuumbestpractices.com

FREE SUBSCRIPTION

DIGITAL EDITION FREE WORLDWIDE | PRINT EDITION FREE TO U.S. SUBSCRIBERS



2022 FOCUS INDUSTRIES!

Food Processing • Food Packaging • Food & Beverage Packaging • Power, Pressure & Flow Measurement

The Magazine for Quality & Reliability in Energy-Efficient Blower & Vacuum Systems

Blower & Vacuum Best Practices is part of a family of magazines dedicated to **Optimizing Onsite Utilities Powering Automation & Processes like Aeration**. This is a technical magazine, reaching 14,300 subscribers, who are dedicated to optimizing industrial blower and vacuum systems and municipal wastewater aeration blower systems.

Industrial Blower & Vacuum Systems

Highly targeted manufacturing and process industry readers optimize the use of industrial blowers and vacuum pumps. These readers work together with sales engineers from industrial distributors of blowers and vacuum pumps prepared to provide “Best Practice” advice. The projects include replacing compressed air with blowers for pneumatic conveying, centralizing vacuum systems, replacing liquid ring with dry vacuum pumps and deploying VSD technology to match load with demand.

“Data loggers were placed on the vacuum system pumps, at an envelope manufacturer, measuring 870,000 kWh at a cost of \$70,000 per year. Interesting to note that the compressed air system consumed 3.5 times less power.”

— Ron Marshall, Marshall Compressed Air Consulting

Aeration Blower Systems

Operators at wastewater treatment plants, process engineers at engineering firms, and municipal sales reps representing blowers receive the magazine. They turn to our editorial pages whose content is directed by noted aeration blower experts. Here they find ideas and advice on calculating/sizing aeration blowers, the latest specification trends from engineering firms and improve their understanding of new Blower Standards like ASME PTC 13.

“Advanced control algorithms like floating control and direct process flow control are becoming more common. These trends will continue to shape and improve blower control technology in the future.”

— Tom Jenkins, JenTech Inc.

To subscribe visit blowervacuumbestpractices.com

Subscribe Now!





Vacuum Upgrades Improve Operations at SupremeX

By Ron Marshall, Marshall Compressed Air Consulting

▶ SupremeX, a Canadian based envelope and packaging manufacturer, with 11 facilities across six provinces, as well as five facilities in the United States, recently upgraded the vacuum system in their Winnipeg based plant. This article discusses the system before and after the changes, and the significant energy savings, plus improved system reliability that resulted. The company also captured a significant utility incentive to help with the cost of a new cutting-edge variable speed vacuum pump.

Background

The Winnipeg facility has multiple production machines that use both compressed air and vacuum energy to produce various styles of envelopes. The vacuum within the machines is mainly used to provide hold down force

along the production line, while folding, forming, and printing the product.

The facility had four lubricated screw vacuum pumps sized at 75 hp and rated at about 1,000 acfm to provide the required vacuum, with the desired target vacuum level of 20 inches Hg. These pumps were all independently controlled with manual start. The production machine operators were trained to start an additional pump, if available, anytime the vacuum level dropped below about 18 inches and to turn off pumps when production levels decreased, and vacuum levels naturally increased.

The vacuum and compressed air systems are located in an isolated corner of the plant away from the production floor. This was done

for practical reasons, the pumps produced a high level of noise and a great deal of heat. This had negative consequences, especially on the compressed air system, because the compressors and pumps are air-cooled and subject to overheating in warm summer months due to a temperature build up.

A few years ago, data loggers were placed to see how the vacuum system was performing. Data loggers were placed to monitor system power consumption, and to determine how the vacuum levels responded to the varying plant production demands. This was done because the plant management and machine adjusters were not totally happy with the way the system pressure was controlled. Figure 1 shows the result, it can be seen there was a very wide

variation in the vacuum level throughout the operating cycle. Sometimes there were not enough vacuum pumps running to support the pressure, causing difficulties within the production machines, and requiring quick action by adjusters to start another pump. Then, when the high demand reduced, vacuum levels would rise to levels far higher than required until adjusters remembered to turn the extra pumps off.

Vacuum Pump Characteristics

One of the characteristics of positive displacement vacuum pumps is that the scfm flow out of the pump varies with vacuum level. This means at each vacuum level, the pump capacity changes, as the vacuum level rises any particular pump will get less and less effective in passing flow. The relationship is as follows:

$$Scfm = Pabs / Patm \times icfm$$

Where:

Pabs is the vacuum level in absolute units, in this case inches Hg

Patm is the absolute atmospheric pressure at site

icfm is the rating of the pump
scfm is the effective amount of standard air volume the pump will pass

For example for a 1000 icfm pump (rounding to 30" Hg for simplicity):

$$18" \text{ Hg} = (30-18)/30 \times 1000 = 400 \text{ scfm flow capability}$$

$$20" \text{ Hg} = (30-20)/30 \times 1000 = 333 \text{ scfm}$$

$$25" \text{ Hg} = (30-25)/30 \times 1000 = 166 \text{ scfm}$$

$$28" \text{ Hg} = (30-28)/30 \times 1000 = 67 \text{ scfm}$$

The trouble with fixed speed vacuum pumps is that this reduction in effective scfm flow at various levels of vacuum comes with very little reduction in power. Therefore, once a vacuum pump is turned on, it starts costing its full amount, whether or not you are using its full flow capability. In fact, what happens is the system vacuum level will rise to a point where the effective flow of the pumps equals that of the production demand, all based on this relationship.

“We knew the SupremeX vacuum system had always been poorly controlled and costly”, said Pat Kerr, District Manager at CFM Air Equipment, the service company responsible for maintaining the vacuum and compressed air systems, “Until the recent introduction of compatible variable speed vacuum pumps there

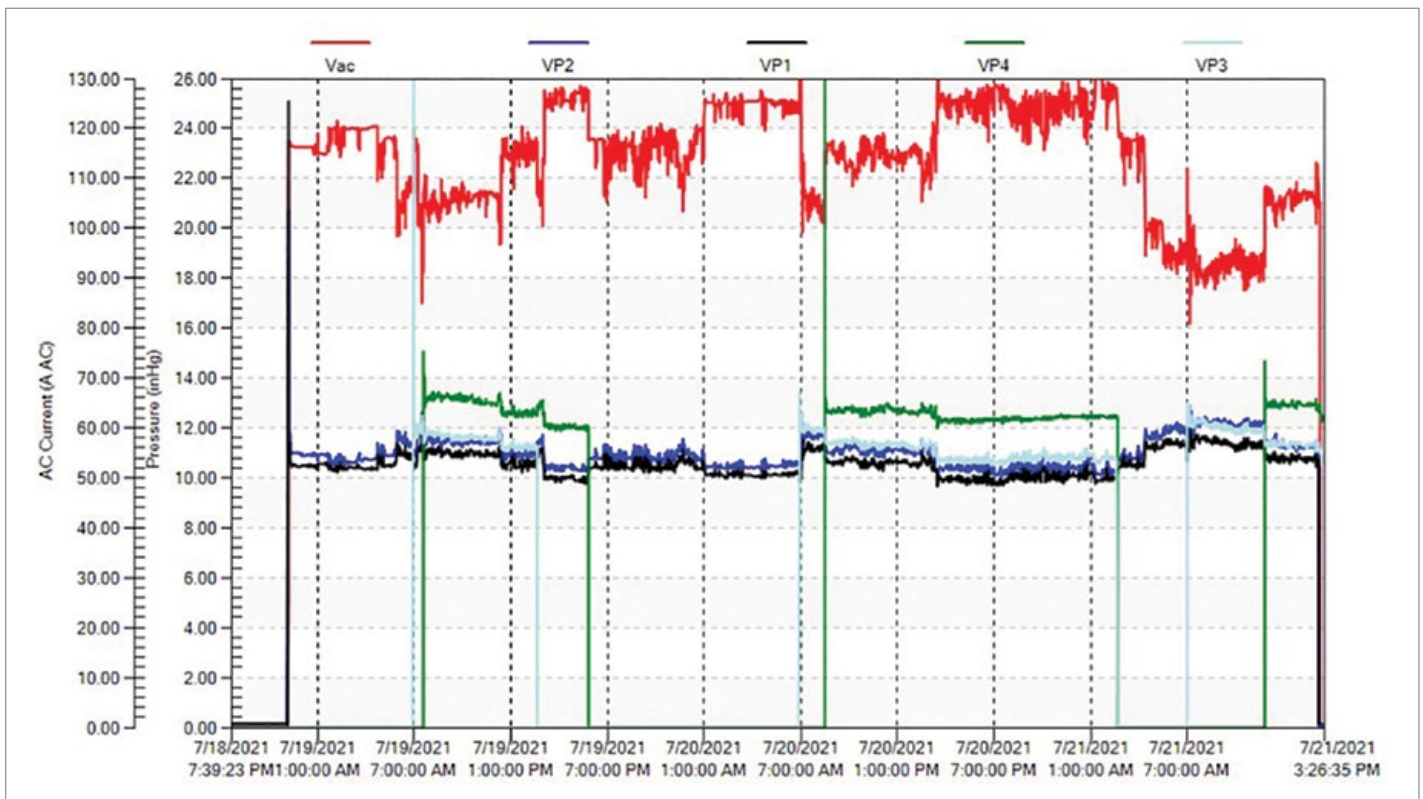

Figure 1: Data logging showed a large variation in vacuum levels throughout the plant production cycle, the lows affected production throughput, the highs cost more energy than needed.

Vacuum Upgrades Improve Operations at SupremeX

wasn't much of an alternative to choose from. But we were finally able to offer some very efficient options that solved a number of problems and saved energy"

SupremeX was no stranger to variable speed drive technology, a few years before their compressed air system was upgraded by adding a main VSD compressor, large storage tank, cycling air dryer, and pressure/flow controllers, all additions well supported

by the local power utility. Based on the data captured by the previous system measurement, and the characteristics of a new more efficient 100 hp VSD controlled vacuum pump, the utility once again was prepared to grant a substantial incentive to help renew the system in an energy efficient way.

Variable speed vacuum pumps save energy because they keep the vacuum at constant levels and control the outlet flow by increasing

or decreasing the pump drive rpm. When controlled in this way the pump reduces its output in proportion to the flow demand, rather than consuming a flat consumption like fixed speed devices. Figure 3 shows the SupremeX vacuum and power profile with a new 100 hp VSD pump operating with one 75 hp fixed speed unit turned on as required. Notice the much more constant vacuum level, this takes away a variable that might plague production activities.

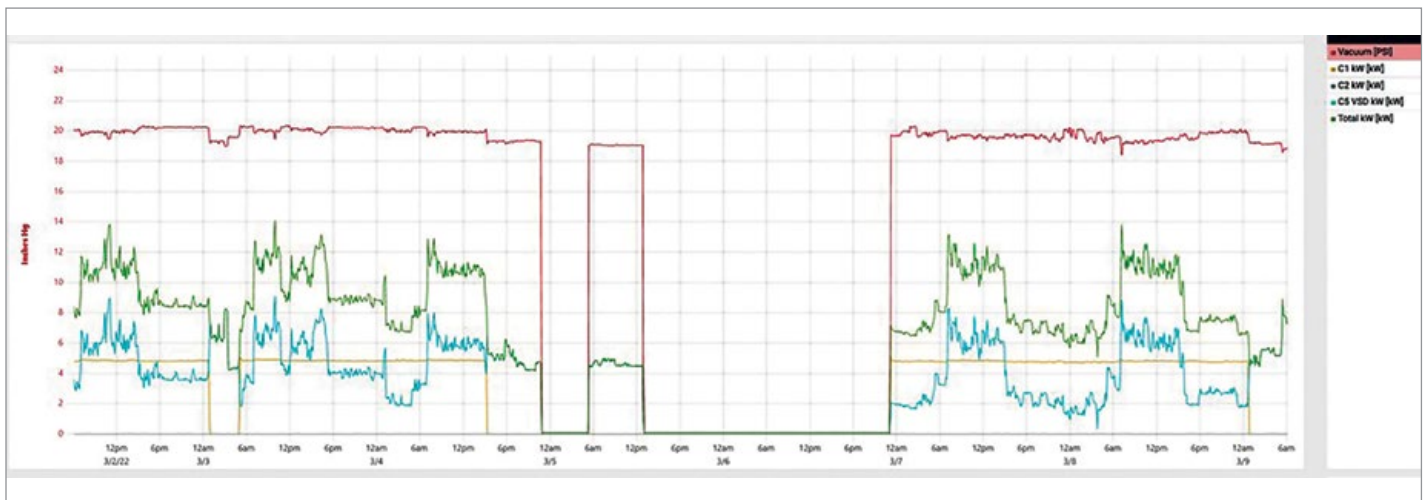

Figure 2: The introduction of the VSD control much better controlled vacuum levels and reduce power consumption by 35%

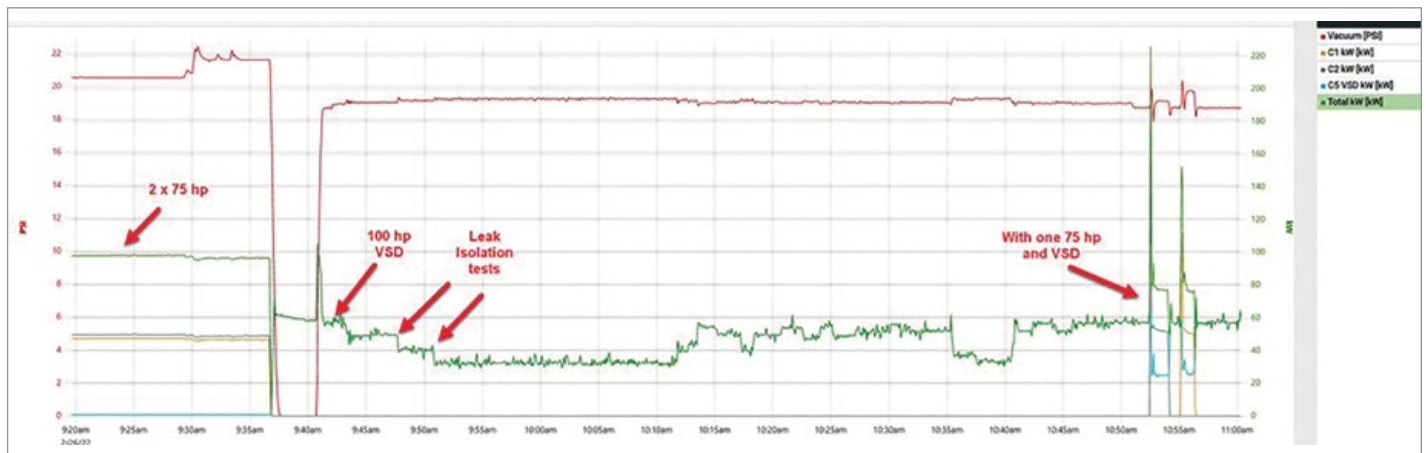

Figure 3: The VSD pump operation shows during non-production times, some leaking valves were identified by isolation. Watching the change in rpm showed the contribution of each leak to the system. Total leakage was about 50% of the capacity of the VSD pump

Assessment Results

Data loggers were again placed on the system after two of the 75 hp fixed speed pumps were removed. The data showed that average power consumption fell to about 65 kW (a 35% reduction). Tests showed that each old 75 hp vacuum pump was equivalent in flow to about 35% of the new 100 hp VSD pump at 20" Hg.

The final verification readings showed some interesting things when it came to non-productive flows during a short half day Saturday shift. Readings showed that with only two small production machines running the plant was consuming about 50% of the capacity of the VSD pump. A subsequent plant inspection showed that there were a number of leaky isolation valves on production machines contributing to the flow. These were identified for repair.

One very useful characteristic of VSD controlled pumps is that plant vacuum leakage can be assessed by simply looking at the pump rpm during low load times. Taking the low flow rpm and dividing by the full load rpm shows you what fraction of the pump is being used to feed leaks. Figure 4 shows an example of one time periods were leakage tests were done. The chart also shows a comparison of the power consumed by two 75 hp fixed speed pumps or the one VSD pump.

Conclusion

This project has proven that introducing VSD technology to vacuum systems has a number of benefits.



Figure 4: The new VSD pump is more efficient, produces less heat, and is much quieter than the old pumps.

“We now have a newer, more reliable, and more efficient system that much better meets our needs”, says Hayden Kent, SupremeX Winnipeg plant manager, “The system keeps the vacuum levels at our desired levels during full production and automatically cuts back its power consumption during our night shifts and on weekends. And, as an added bonus, I notice it is much quieter and cooler over in that corner of the plant.”

This project shows the value of measuring a system both before and after a project to

determine the savings, and that vacuum leakage should be assessed. Final verification found various unanticipated flows that needed to be attended to. As a result of the improvement efforts, the plant production is now running more efficiently, and more reliably, which gives management a high degree of satisfaction, especially when it comes time to pay the electrical bill. **BP**

For more information about this article, contact Ron Marshall at Marshall Compressed Air Consulting, tel: 204-806-2085.

For similar articles on **Industrial Vacuum System Assessments**, visit <https://www.blowervacuumbestpractices.com/system-assessments/vacuum-systems>



Visit our Webinar Archives to listen to expert presentations on **Industrial Vacuum Technology** at <https://www.blowervacuumbestpractices.com/magazine/webinars>

Get the Most Out of Centrifugal Blower Control Upgrades

By Jeremiah Brown, BSEE/BSCE



▶ Single-stage centrifugal blowers are a proven technology that have been around for many years and will probably be here for many years to come. A well maintained machine can last for decades and will likely outlast its original control system. Even if the control system is still in good working order the components might already be end of life and hard to replace if any of them fail. If you are thinking about modernizing the hardware (PLC / HMI / Instruments) this is also a great opportunity to make the system a little smarter and user friendly. Here are a few suggestions to getting

the most out of a controls upgrade for your single stage centrifugal blower.

Standby Mode for Easy Testing

A key challenge when upgrading the blower controls at an existing plant is the ability to test the controls without disturbing the process. It feels a lot like doing road construction on a busy highway. Regardless of how thorough the checks are before the first post upgrade run of the machine, there always seems to be some little missing piece of the puzzle that prevents the blower from operating perfectly.

Imagine a wastewater treatment plant with three blowers that is typically running one blower at a time. In order to prevent over pressurizing the header, the running blower must be shut down before the upgraded blower can put air into the process. This is not always convenient since it requires coordination with operators who might be busy with other tasks. A failed start of the upgraded blower can also cause greater upsets to the aeration system by losing process air longer than expected.

A simple improvement that can be made to the control system is the addition of standby mode. Standby mode will allow the blower to begin its normal start sequence but once the main motor is started, it will keep the discharge valve closed, blow off valve open, and vanes at minimum. Therefore, the blower will be running but not putting air into the process. Now that the blower is running, all instruments can be verified to be reading within proper ranges. If any instrument causes the blower to trip and shut down, the aeration system will not be affected. When the blower is running in standby mode this is also a great time to check the EStop. With no back pressure the blower will not surge, thump, and shake the blower building when the Estop is pressed.

Standby mode can be used to not only carefully start a blower but to very cautiously shut it down as well. If the first blower has been fully upgraded and tested, and now it is time to test the second blower, the first blower can be placed in standby mode until the second blower is fully online. Therefore, if the second blower shuts down while transitioning to put air into the process, the first blower can quickly transition back to “process mode” without executing the entire start sequence.

It is important to note that in standby mode the blower should always keep the vanes at minimum. If the vanes are opened with no back pressure from the system, excessive air flow through the blower can potentially stress and damage the impeller.

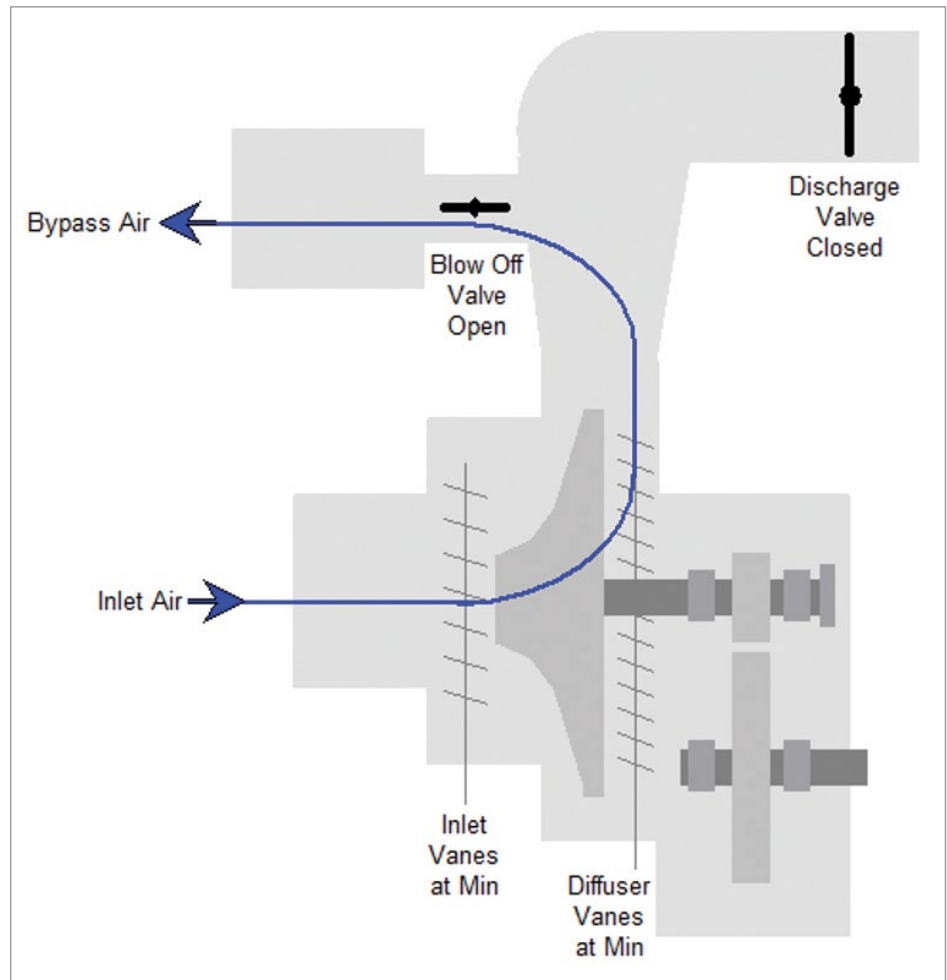

Figure 1. Blower Running in Standby (No air to process)

Process Variable Capture vs Trending

Trend analysis is an excellent tool for determining root cause failure. However, it is not always convenient when troubleshooting blower issues. Although most blower HMIs have the ability to trend process variables, they were not meant to be historians. Plants that have a DCS or SCADA with a historian are helpful if they have the trend data you are looking for, which is sometimes not the case.

A simple improvement that can be easily implemented on almost any HMI is to capture the process variable’s current value as part of the alarm message. Therefore, instead of an alarm message that reads “High thrust bearing temperature trip” it could also capture the temperature when the blower shut down and read “High thrust bearing temperature trip (220°F)”. One reason to capture this value is to quickly determine if the number is reasonable or not.

Get the Most Out of Centrifugal Blower Control Upgrades

Some RTD modules for PLCs can be set to upscale or downscale when it detects a disconnected wire. If the blower shuts down and the alarm message reads “High thrust bearing temperature (1562°F)”, this is obviously from a disconnected RTD wire and not from an overheated thrust bearing. When the on call technician receives the alert, this information will make it obvious that there is a wiring issue, not a mechanical issue with the blower. If the controls are not connected to any type of alerting system, this feature makes it easy for an operator to take a picture with their smartphone and text or email it to the appropriate person.

Process variable (PV) capture can be especially useful for a surge trip. By capturing key process variables a trained engineer or service technician can quickly zero in on the problem. Was the differential pressure 10.8 psi on a blower rated at 9.0 psi when the surge

occurred? That would be an obvious reason for the blower to have surged. Instead of thinking there is something wrong with the blower, maybe now is a good time to figure out why all the basin valves pinched down too far and spiked the pressure. PV capture is not meant to replace a SCADA historian but can offer extremely useful troubleshooting information for very little programming effort.

Automated Check Valve Leak Detection

It is possible for a blower to surge during the start sequence if the discharge piping has a failed check valve. If the check valve does not open fully, it can create too much back pressure and therefore surge the blower. A check valve that does not open fully might also not close fully when the blower is off. One option for preventing this type of surge during the start sequence is an adjustable pressure limit. If the differential pressure goes

above the set limit during the start sequence, then do not allow the blow off valve to close any further. To determine if the source of the failed start is a faulty check valve, a couple of different methods can be utilized depending on how the blower is equipped.

One way to know if the check valve on the discharge piping has failed is by detecting blower shaft rotation when the blower is off. If the blowers are connected to a common header and at least one blower is running, the header will be pressurized. If the discharge valve is open, or the system does not have a discharge valve, a failed check valve can allow air to leak through and spin the impeller backwards on a machine that is idle. However, not all blowers come equipped with the instruments necessary to detect shaft rotation when the blower is off.

Another option for determining if the check valve is leaking is to perform a simple procedure when the blower in question is off and at least one blower is running. To perform this procedure, note the value of the inlet or discharge temperature transmitters, open the discharge valve, and then close the blow off valve. Wait for a few minutes and see if the inlet or discharge air temperatures rise excessively. If the check valve is not leaking the temperatures will not change. If the check valve has failed, there will be a noticeable rise in temperature. This procedure is a simple but effective method for checking for a leaky check valve. If the hardware is already in place, it takes very little code to add this feature when upgrading the controls.

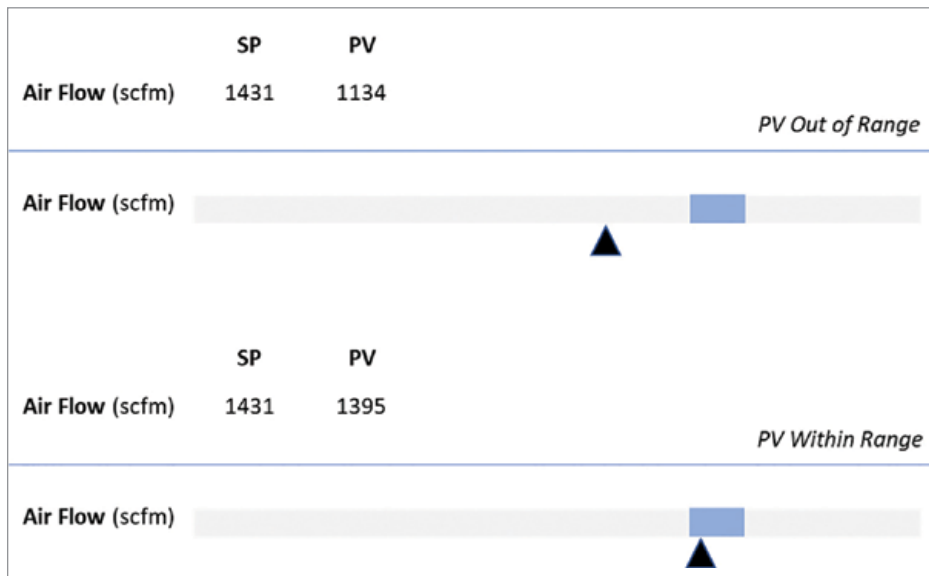

Figure 2. Tabulated Data vs High Performance Graphics

High Performance Graphics

No upgrade is complete without addressing the graphics. Now is a great time to consider using some of the principles of high performance graphics. There is an excellent book written on this topic titled “The High Performance HMI Handbook” by Bill Hollifield et al, which discusses this topic in great detail. High performance graphics are intuitive and truly make the display a Human/Machine Interface. A simple concept to implement is the use of the indicator / bar graph for showing the setpoint and process variable. For any given setpoint there is an acceptable range. The image below shows an air flow setpoint or 1431 SCFM with an acceptable range of +/- 75 SCFM. Two scenarios are shown where the black triangle represents the PV value and blue band the acceptable range. Using this approach it is quite obvious when the air flow setpoint is being met and when it is out or range.

Another recommendation from the High Performance HMI Handbook that is worth considering is replacing the old red/green paradigm with dark/light indicators. Imagine being an operator at a plant whose standard color scheme is “red on” and “green off”. Every day on the way home from the plant you must readjust your thinking when you encounter a stop light. Now red means stop and green means go. One advantage of the stop light is that color alone is not the only indicator of state. Stop lights are designed with red at the top and green at the bottom. Therefore, if you can’t distinguish between these colors it is still possible to determine whether to stop or go based on the position of the lights. This is also

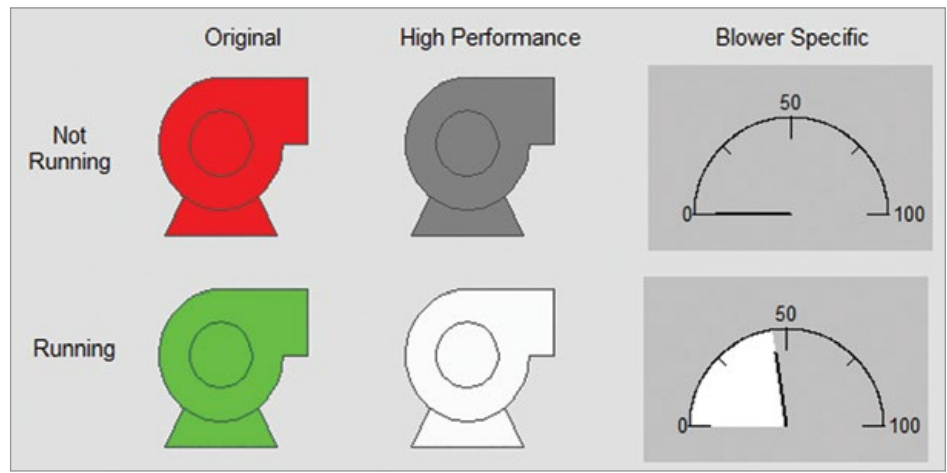

Figure 3. On / Off Display Methods

a principle of high performance graphics which recommends never using color alone as a state change indicator.

Single stage centrifugal blowers have the unique property of limited turn down. I.e., the air flow output at minimum might be 45 percent of the air flow at maximum. Based on this unique property of blowers another possible approach to indicate the on/off state of the blower is with a gauge. When the blower’s main motor is off the gauge reads 0% output, when the main motor is running at minimum (or motor running and in start or stop sequence) 45%, and then scaling the output between 45-100% during normal online operations.

Conclusion

These are just a few examples of how the local single-stage centrifugal blower controls can

be improved when upgrading the hardware. Software is never done. This is not to suggest that a controls upgrade should be an exercise in endless feature creep. The suggestion is to make it something more than just replacing the hardware. The controls upgrade is the perfect opportunity to incorporate ideas from field service technicians, engineers, and operators, especially operators since they will be using this equipment for the next 20 years. **BP**

About the Author

Jeremiah Brown, BSEE, BSCE, has worked as a Controls Engineer for the last 8 years primarily with single stage centrifugal compressors and wastewater treatment aeration systems. He can be contacted at email: miah.brown@gmail.com

To read similar articles on **Aeration Blower Technology**, please visit <https://blowervacuumbestpractices.com/technology/aeration-blowers>



Visit our Webinar Archives to listen to expert presentations on **Aeration Blower Systems** at <https://www.blowervacuumbestpractices.com/magazine/webinars>

BLOWER & VACUUM TECHNOLOGY NEWS

Pfeiffer Vacuum Introduces New Multi-Stage Roots Pumps ACP 90

Pfeiffer Vacuum, one of the world's leading suppliers of vacuum technology, introduces new multi-stage Roots pumps ACP 90, which are designed for oil- and particle free applications in the pressure range between atmosphere up to 3x10⁻² hPa. These vacuum pumps meet the requirements where clean and dry vacuum is needed like drying, sterilization, coating as well as semiconductor and R&D applications.

With their unique design, these pumps are robust and can withstand frequent pump downs. Highly valuable materials render the pumps more resistant to light corrosive gases. ACP 90 is ideal when pumping large amount of condensable gases like in drying applications, high humidity environments or large insulating volume pumping.

As Jean-Philippe Briton, Product Manager at Pfeiffer Vacuum, said, "We are particularly

proud of the built-in intelligence that allows for high pumping speed at high pressure, which is important when pumping large volumes.

With a very low power consumption of 2 kw at atmospheric pressure the ACP 90 is also an energy efficient solution for this type of use."

In addition, the pump also fulfills CE and UL/CSA standards. Find more information about ACP 90 at <https://t1p.de/pfeiffer-vacuum-ACP90-en>.

About Pfeiffer Vacuum

Pfeiffer Vacuum is one of the world's leading providers of vacuum solutions. In addition to a full range of hybrid and magnetically levitated turbopumps, the product portfolio comprises backing pumps, leak detectors, measurement and analysis devices, components as well as vacuum chambers and systems. Ever since the invention of the turbopump by Pfeiffer Vacuum, the company has stood for innovative solutions and high-tech products in the analytical, industrial, research & development, semiconductor and future

technologies markets. Founded in 1890, Pfeiffer Vacuum is active throughout the world today.

The company employs a workforce of more than 3,500 people and has more than 20 sales and service companies as well as 10 manufacturing sites worldwide. For more information, please visit www.pfeiffer-vacuum.com.

Leybold Presents the NDi Central Vacuum System

In applications requiring a clean central vacuum, the new NDi standardized vacuum system ensures a reliable supply. This innovation from Leybold is based on the dry-running NOVADRY screw pump, which is robust over the entire pressure range, and the integrated VAControl CAB controller for smart control. The range of applications for the NDi central system includes food and packaging processes, research & development, vacuum conveying systems as well as medical and laboratory applications.

In the areas of application, hygiene, economy, reliability, compactness and ease of operation are important to the operators. For vacuum values such as the final pressure or pumping speed, process-dependent flexibility is required. "In view of these requirements, the strengths of our oil-free, air-cooled screw vacuum pump NOVADRY come into their own," said the responsible Product Manager, Dennis Schröder. "In addition to accumulating air and water vapor mixtures, the robust screw vacuum pump introduced in 2019 tolerates, among other things, contamination of gas flow with organic acids, food additives or other residues. This ensures long operating times," Schröder said.



New Multi-Stage Roots Pumps ACP 90 from Pfeiffer Vacuum.



Leybold's NDi vacuum systems are available fully assembled.

By equipping the standardized NDi pump systems with the VAControl CAB, Leybold ensures intelligent control of all processes. Continuous data recording ensures maximum production quality, with the encrypted pump data available regardless of location. Individual users can access the server at any time – users can choose between local, remote or cloud connectivity. Direct control of the system is possible via various interfaces and end devices.

The intelligent software functions that Leybold has stored in the control system are all practical and user-friendly and serve the entire process planning. For example, they can be used to control the starts and stops of several pumps, the pressure control and the cloud communication via GENIUS. The maintenance and service recommendations of the vacuum system are generated by the powerful computer depending on the operating times.

The standardized NDi vacuum systems are available fully assembled in different pumping speeds as ND 400i with 400 m³/h pumping speed and as ND 600i version with 600 m³/h pumping speed. A strong vacuum performance up to a working pressure of 5 mbar, intelligent pressure adjustment and control of the target pressure complete the features of the smart NDi vacuum package from Leybold.

About Leybold

Leybold is a part of the Atlas Copco's Vacuum Technique business area and offers a broad range of advanced vacuum solutions for use in manufacturing and analytical processes, as well as for research purposes. The core capabilities centre on the development of application- and customer-specific systems for the creation of vacuums and extraction of processing gases. Fields of application are secondary metallurgy, heat treatment, automotive industry, coating technologies, solar and thin films such as displays, research & development, analytical instruments, food & packaging, as well as a multitude of other classic industrial processes. For more information, visit www.leybold.com.

GF Introduces LOKX System Ductile Iron Fitting

GF Piping Systems (GF) has introduced the proprietary LOKX System Ductile Iron Fitting from GF Central Plastics, designed specifically for use with C900 PVC and CIOD HDPE pipe in buried applications. The new system eliminates the need for any bolts or assembly tools, resulting in a savings of up to 80% in installation time and labor costs compared to mechanical joint restraint (MJ) fitting systems.

FREE SUBSCRIPTION

DIGITAL EDITION FREE WORLDWIDE
PRINT EDITION FREE TO U.S. SUBSCRIBERS



**EVERY ISSUE CONTAINS
BEST PRACTICES FOR**

**Industrial Vacuum
Vacuum Generation
Industrial & Aeration
Blowers**

Blow-Off Air

Subscribe Now!



Subscribe at
blowervacuumbestpractices.com

Blower & Vacuum Technology News



GF's LOKX System Ductile Iron Fitting is designed specifically for use with C900 PVC and CIOD HDPE pipe in buried applications.

Engineered with a deep bell design, the LOKX System's ductile iron push-on style fitting has deflection capabilities of up to a total of 10° in any direction (5° deflection per bell). This flexibility allows for extreme ground movement, making it suitable for seismic applications.

Another key feature to the LOKX System is its internal self-restraining gasket that eliminates pipe-to-pipe and pipe-to-fitting separation, even at high pressures. The self-restraining gasket has a low insertion force in addition to a lip-seal design with 316 stainless steel gripping segments. When fully engaged, the segments self-engage to form a 360° restraint that prevents pipe distortion and point loading that MJ restraints cause. Compatible with C900 PVC and CIOD HDPE pipe, the LOKX System is manufactured to AWWA C153 with a minimum working pressure of 350 psi.

In the water and wastewater fitting market, the installation for mechanical joint fittings and joint restraints can be time consuming and difficult to install depending on ditch conditions. The mechanical joint fitting was

originally designed for use on heavy ductile iron pipe, yet the majority of all installations today are on PVC pipe in sizes 12" and smaller. Designed specifically for use on PVC and PE pipe, the LOKX Systems greatly reduces human error and the amount of time required to install the traditional MJ restraint systems.

GF's LOKX System successfully solves the problems associated with traditional MJ fitting systems. Its internal restrained fitting is leak resistant, fast to install, and not subject to pipe distortion and point loading as seen with MJ restraint systems. The LOKX System can be used for a variety of buried applications in water and wastewater, seismic areas, corrosive regions, coastal areas with brackish soils, and horizontal directional drilling. UL and FM approvals are pending.

For more information on the LOKX System, visit <https://www.gfps.com/en-us/products-solutions/innovation/loxx-system.html> or contact GF Piping Systems toll free at 800 854-4090 or us.ps@georgfischer.com.

About GF Piping Systems

As the leading flow solutions provider for the safe and sustainable transport of fluids, GF Piping Systems creates connections for life. The division focuses on industry-leading leak-free piping solutions for numerous demanding end-market segments. Its strong focus on customer-centricity and innovation is reflected by its global sales, service, and manufacturing footprint and its award-winning portfolio, including fittings, valves, pipes, automation, fabrication, and jointing technologies. GF Piping Systems has its own sales companies in 31 countries, which means it is always by its customers'

side. Production sites in 36 locations in America, Europe, and Asia ensure sufficient availability and quick, reliable delivery. In 2021, GF Piping Systems generated sales of CHF 1'971 million and employed 7'686 people. GF Piping Systems is a division of Georg Fischer AG, founded in 1802 and headquartered in Schaffhausen, Switzerland. For more information visit www.gfps.com.

Exair Offers Custom Pneumatic Conveyors

EXAIR's Line Vac Air Operated Conveyors provide an efficient method of converting ordinary pipe, hose or tubes into powerful in-line conveyors. To accommodate the wide variety of unique problems manufacturers face, EXAIR has the ability to customize and tailor Line Vacs to different specifications. Certain processes may require customizations like unique sizes, shapes and materials in order for the product to be a perfect fit for their system. EXAIR will work in collaboration with the customer to fabricate the best possible Line Vac solution for easy and efficient conveyance.

For customers with space limitations, smaller sizes can be created while still offering the same



EXAIR's Line Vacs can be customized.

quality of conveyance. In situations where the Line Vac requires a specific flange mounting option, EXAIR can accommodate. Locations requiring custom mounting holes, brackets or inlet positions are possible. For applications where stock aluminum, or 303 and 316 stainless steel won't work, alternate materials like PVDF, OVC or PTFE can be utilized. Even in extreme environments, EXAIR can produce both heavy duty or high temperature iterations to handle even the toughest material or conditions. Other details like the customer's particular hose size, or pipe threading are specifications that EXAIR will have no problem accommodating.

Stock Line Vac models include standard, heavy duty, high temperature, light duty and sanitary flange. All versions are able to be customized to a customer's specific needs. For help solving any specific conveyance problems, please contact an Application Engineer. All Line Vacs are CE compliant, and prices start at \$107.

For more information, visit <https://exair.co/lvspec>.

Piab Develops BGX Suction Cup for Handling Flimsy Bags

Bags made of thin plastic film such as those used for salad leaves and fresh herbs, or the aluminium foil bags used for chips and other snacks are flimsy and often just as fragile as their contents. New biodegradable and recyclable materials are becoming increasingly popular, and with it the challenges of bag handling increase. The thinner the bags become, the easier they can be sucked into and damaged by the suction cup's grip. To avoid any damage to the bag or indeed to their contents, the lip of the suction cup needs to provide outstanding sealing capability even at low vacuum levels.



The BGX suction cup is suitable for applications in E-commerce, Fast Moving Consumer Goods, Secondary food picking, Fashion, and other industries where bags are handled.

Piab's new BGX bag handling suction cup has been specially developed to be the perfect bag picker for flimsy and oversized bags addressing the challenges presented by this application. The lip of the bag cup is designed with outstanding sealing capability also at low vacuum level. Produced as a one-piece suction cup with two bellows, the suction cup will easily pick bags of different heights with a safe and stable hold of the product in the fast/semi-fast robot applications.

The BGX suction cups are made of FDA & EU approved blue silicone for direct contact with food and are suitable for both high and low temperature applications. The suction cup can be configured by choosing between 3 sizes of the lip diameters 34, 41, and 48 mm and 6 different aluminium push-in fittings designed to attach safely to the robust neck of the cups.

Piab's solutions for automated bag handling rely on our long-standing expertise in vacuum

and ejector technology as well as the use of our specialized suction cups. With over 20 years' experience in developing bag handling suction cups, we still constantly challenge ourselves to create new cups for increasingly targeted applications supporting your success.

About Piab

Piab provides smart solutions for the automated world, helping thousands of end users and machine producers in e-commerce logistics, food, pharma, automotive and other manufacturing industries to improve energy-efficiency, productivity and working environments. With almost 500 employees and SEK 1.2 bn in sales 2018, Piab is a global organization, serving customers in almost 70 countries from a network of subsidiaries and distributors. By leveraging the ongoing technological development in automation and robotics, and targeting high-growth segments and geographies, Piab's vision is to become the global leader in gripping and moving solutions. For more information, visit www.piab.com.

THE MARKETPLACE

BLOWER & VACUUM BEST PRACTICES
www.blowervacuumbestpractices.com

ADVERTISER INDEX

Company	Page	Web Site
Atlas Copco	Outside Back Cover	https://www.atlascopco.com/blowers-usa
Kaeser Compressors	Inside Front Cover	https://us.kaeser.com/bvbp
IPPE	Inside Back Cover	https://www.ippexpo.org
Busch Vacuum Solutions	7	https://www.buschvacuum.com/us/en
Best Practices Webinars	9, 14, 17	https://www.airbestpractices.com/magazine/webinars
Inovair	11	https://inovair.com
Aerzen USA	13	https://www.aerzen.com/en-us.html

TECHNOLOGY & JOBS

Job & Product Marketplace Advertising Information

Reach 16,200+ readers of Compressed Air Best Practices® Magazine with Marketplace Ads every month! Job Marketplace ads are also placed for one month on www.airbestpractices.com and promoted in our three monthly e-newsletters.

Ad dimensions are 2.36" wide x 3.91" tall. We can help you design the ads. Send us your logo, product photo, and text to rod@airbestpractices.com. We recommend 20-50 total words of text.

Prices are \$625 per Job or Product Marketplace Ad (\$440 if 6 or more ads are placed). Contact Rod Smith at rod@airbestpractices.com to schedule your Marketplace Ads.



Advertising/Editorial

Rod Smith • rod@airbestpractices.com • Tel: 412-980-9901

Subscriptions Administration

Patricia Smith • patricia@airbestpractices.com • Tel: 412-980-9902

A Publication of

Smith Onandia Communications LLC

37 McMurray Rd., Suite 104, Pittsburgh, PA 15241

Blower & Vacuum Best Practices is published quarterly and mailed together with Compressed Air Best Practices®. Compressed Air Best Practices® (USPS# 17130) is published monthly except January-February combined by Smith Onandia Communications LLC, 37 McMurray Rd., Suite 104, Pittsburgh, PA 15241. Periodicals postage paid at Pittsburgh, PA and additional mailing offices. POSTMASTER: Send address changes to: Compressed Air Best Practices®, 37 McMurray Rd, Suite 104, Pittsburgh, PA 15241.

Compressed Air Best Practices® is a trademark of Smith Onandia Communications, LLC. Publisher cannot be held liable for non-delivery due to circumstances beyond its control. No refunds. SUBSCRIPTIONS: Qualified reader subscriptions are accepted from compressed air professionals, plant managers, plant engineers, service and maintenance managers, operations managers, auditors, and energy engineers in manufacturing plants and engineering/consulting firms in the U.S. Contact Patricia Smith for subscription information at tel: 412-980-9902 or email: patricia@airbestpractices.com. REPRINTS: Reprints are available on a custom basis, contact Patricia Smith for a price quotation at Tel: 412-980-9902 or email: patricia@airbestpractices.com. All rights are reserved. The contents of this publication may not be reproduced in whole or in part without consent of Smith Onandia Communications LLC. Smith Onandia Communications LLC. does not assume and hereby disclaims any liability to any person for any loss or damage caused by errors or omissions in the material contained herein, regardless of whether such errors result from negligence, accident, or any other cause whatsoever. Printed in the U.S.A.

IPPE
IPPE
IPPE
IPPE
IPPE
IPPE
IPPE

DELIVERS INNOVATIVE TECHNOLOGY

The 2023 IPPE is the only exposition of its kind showcasing the latest solutions for the global animal food and protein industries. With more than 1,200 exhibitors, IPPE will deliver the most innovative technology at this powerhouse of a show in January!

Registration opens in October

ippexpo.org

 INTERNATIONAL
IPPE[®]
PRODUCTION & PROCESSING EXPO

JAN. 24 - 26, 2023
ATLANTA, GA USA

The Atlas Copco logo is displayed in white, italicized serif font within a blue rectangular box that has two white horizontal bars above and below the text.The background of the advertisement shows two large, dark grey industrial blowers situated outdoors at a wastewater treatment plant. They are enclosed within a large, glowing green dome with a hexagonal grid pattern. A glowing blue padlock icon is positioned between the two blowers. In the bottom left corner, there is a blue triangular graphic containing white technical drawings of a blower component with various dimensions and labels.

Unlock Your Plant's Potential

We know how important aeration is to wastewater treatment. It plays a critical role in protecting both your processes and your reputation. No matter which of our seven technologies you choose, we design our blowers with you in mind. Boasting long service intervals, 24/7 remote monitoring, leading energy efficiency, and a design focused on ease of service.



866-472-1013



www.atlascopco.com/blowers-usa